

NOTES: (UNLESS OTHERWISE SPECIFIED)

1. DIMENSIONS IN INCHES, [mm]
2. DO NOT CUT, DRILL OR MODIFY
3. DO NOT EXCEED RECOMMENDED LOAD SPECIFICATIONS

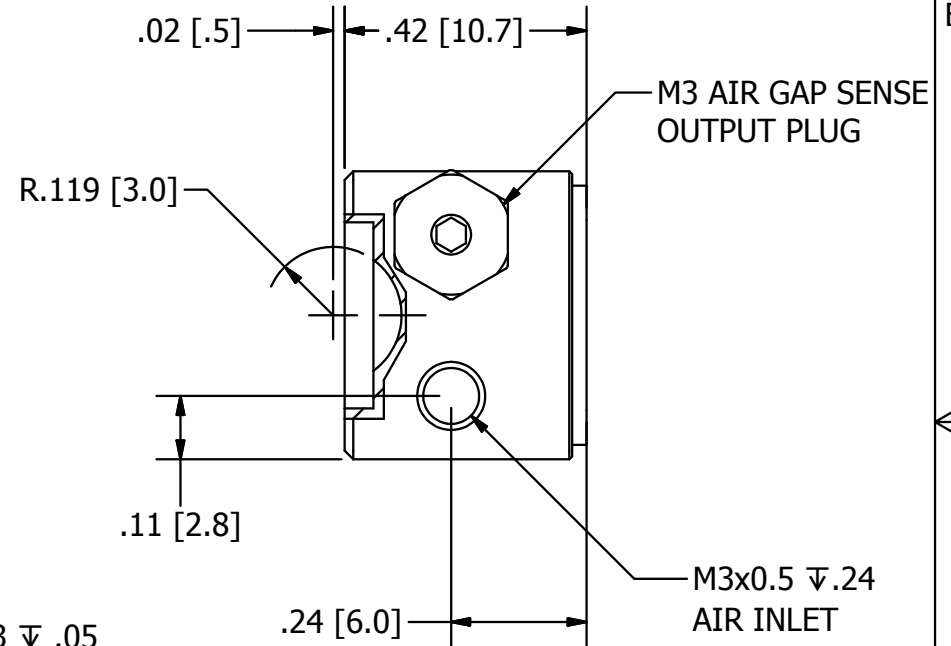
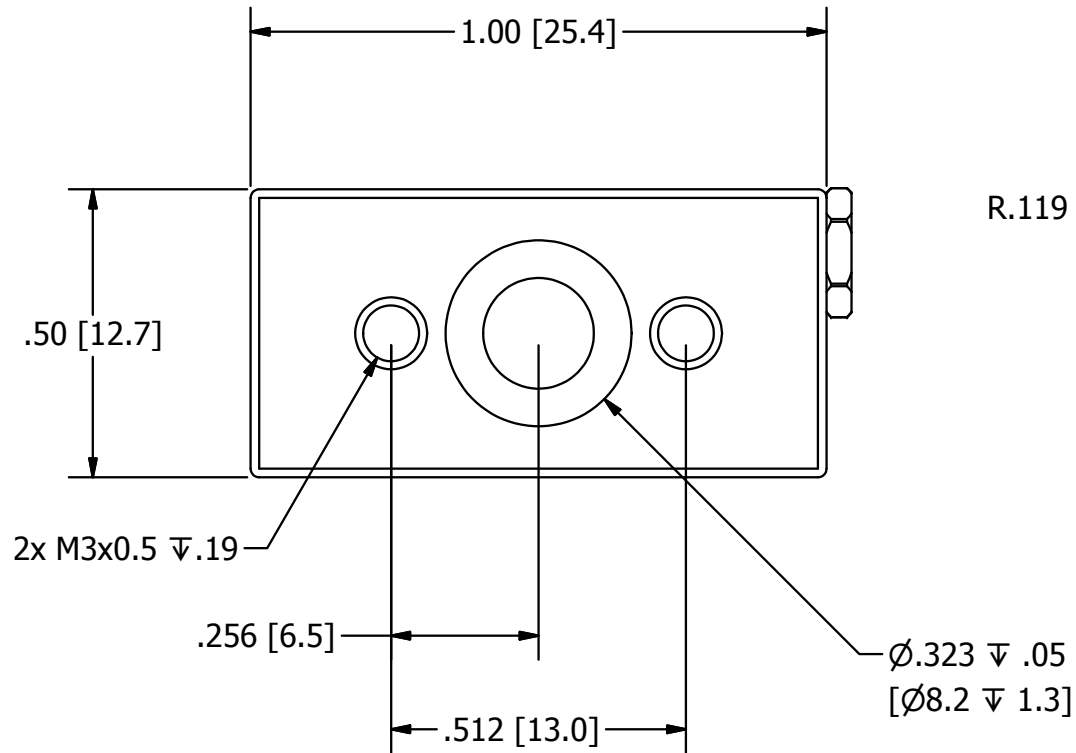

3/8/2012

14 VILLAGE LANE - WALLINGFORD, CT 06492
TEL 203.284.9112 - FAX 203.672.0371
WEB: WWW.SPECIALTYCOMPONENTS.COM
MAIL: INFODIRECT@SPECIALTYCOMPONENTS.COM

TITLE
LSAP050100 AIR BEARING
SENSE

DRAWING NUMBER
610-22080

© 2011 - SPECIALTY COMPONENTS