

NOTES: (UNLESS OTHERWISE SPECIFIED)

1. DIMENSIONS IN INCHES, [mm]
2. DO NOT CUT, DRILL OR MODIFY
3. DO NOT EXCEED RECOMMENDED LOAD SPECIFICATIONS

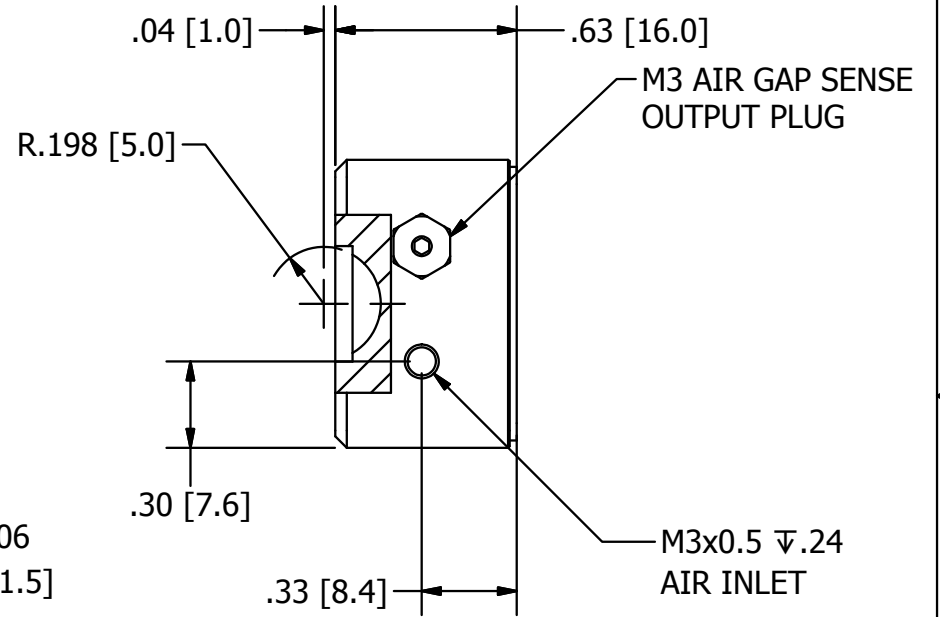
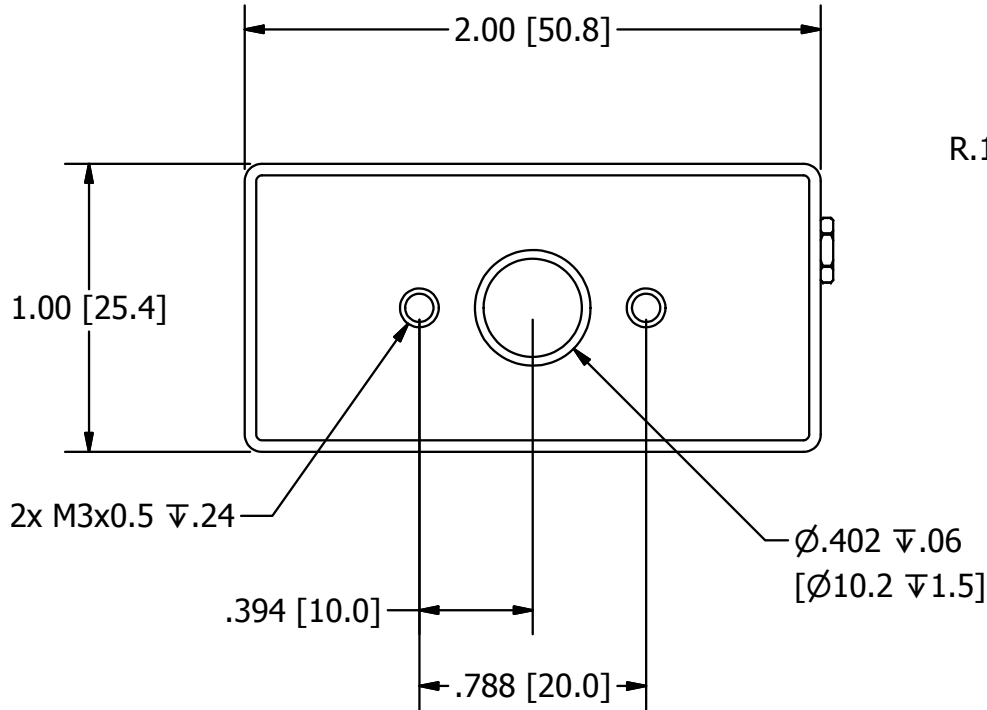

3/8/2012

14 VILLAGE LANE - WALLINGFORD, CT 06492
 TEL 203.284.9112 - FAX 203.672.0371
 WEB: WWW.SPECIALTYCOMPONENTS.COM
 MAIL: INFODIRECT@SPECIALTYCOMPONENTS.COM

TITLE
 LSAP100200 AIR BEARING
 SENSE

DRAWING NUMBER
610-22083

© 2011 - SPECIALTY COMPONENTS